

MAL209635272E3

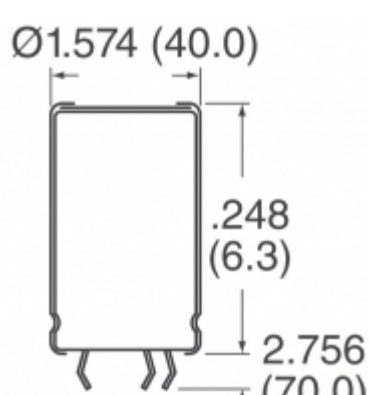

Part Number: MAL209635272E3
Manufacturer: Electro-Films (EFI) / Vishay
Description: CAP ALUM 2700UF 20% 350V SNAP
Data sheet: [096 PLL-4TSI \(MAL2096\) Series](#)
[Aluminum Electrolytic Capacitors Guide](#)

RoHS Status: Lead free / RoHS Compliant
Ship From: Hong Kong
Shipment Way: DHL/Fedex/TNT/UPS/EMS

Images are for reference only.
 See Product Specifications for product details.
Buy MAL209635272E3 with confidence from Component-World.HK, 1 Year Warranty







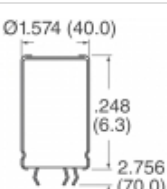
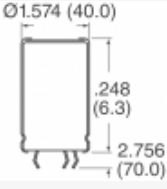
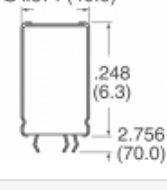
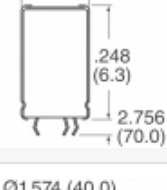
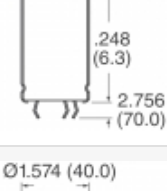
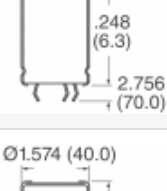
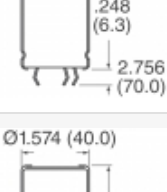

[Request For Quotation](#)

PRODUCT PARAMETER

Part Number	MAL209635272E3	Manufacturer	Electro-Films (EFI) / Vishay
Description	CAP ALUM 2700UF 20% 350V SNAP	Lead Free Status / RoHS Status	Lead free / RoHS Compliant
Quantity Available	2758 pcs	Data sheet	096 PLL-4TSI (MAL2096) Series Aluminum Electrolytic Capacitors Guide
Category	Capacitors	Voltage - Rated	350V
Tolerance	±20%	Surface Mount Land Size	-
Size / Dimension	1.772" Dia (45.00mm)	Series	096 PLL-4TSI
Ripple Current @ Low Frequency	9.2A @ 100Hz	Ratings	-
Polarization	Polar	Packaging	Tape & Box (TB)
Package / Case	Radial, Can - Snap-In - 4 Lead	Operating Temperature	-40°C ~ 85°C
Mounting Type	Through Hole	Moisture Sensitivity Level (MSL)	1 (Unlimited)
Manufacturer Standard Lead Time	13 Weeks	Lifetime @ Temp.	5000 Hrs @ 85°C
Lead Spacing	0.886" (22.50mm)	Lead Free Status / RoHS Status	Lead free / RoHS Compliant
Impedance	30 mOhms	Height - Seated (Max)	3.937" (100.00mm)
ESR (Equivalent Series Resistance)	149 mOhm @ 100Hz	Detailed Description	2700µF 350V Aluminum Electrolytic Capacitors Radial, Can - Snap-In - 4 Lead 149 mOhm @ 100Hz 5000 Hrs @ 85°C
Capacitance	2700µF	Applications	General Purpose

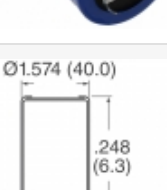
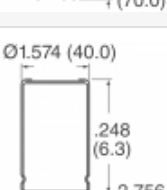
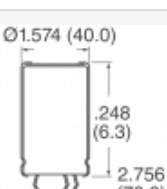
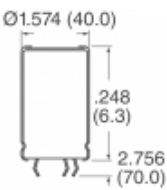
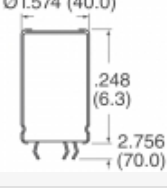
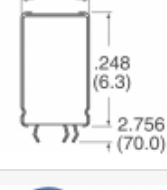
Component-World.com is a Reliable Stocking Distributor of Electronic Components. We specialize in all Electro-Films (EFI) / Vishay series electronic components. We have 2758 pieces of Electro-Films (EFI) / Vishay MAL209635272E3 in stock available now. Request a quote from electronics components distributor at Component-World.com, our sales team will contact you within 24 hours.
 RFQ Email: info@Components-World.com

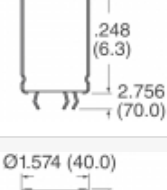
RELATED PRODUCTS

	Part#: MAL209637182E3 Description: CAP ALUM 1800UF 20% 450V SNAP	Manufacturers: Electro-Films (EFI) / Vishay	RFQ
	Part#: MAL209637152E3 Description: CAP ALUM 1500UF 20% 450V SNAP	Manufacturers: Electro-Films (EFI) / Vishay	RFQ
	Part#: MAL209635222E3 Description: CAP ALUM 2200UF 20% 350V SNAP	Manufacturers: Electro-Films (EFI) / Vishay	RFQ
	Part#: MAL209635152E3 Description: CAP ALUM 1500UF 20% 350V SNAP	Manufacturers: Electro-Films (EFI) / Vishay	RFQ
	Part#: MAL209636222E3 Description: CAP ALUM 2200UF 20% 400V SNAP	Manufacturers: Electro-Films (EFI) / Vishay	RFQ
	Part#: MAL209637102E3 Description: CAP ALUM 1000UF 20% 450V SNAP	Manufacturers: Electro-Films (EFI) / Vishay	RFQ
	Part#: MAL209636152E3 Description: CAP ALUM 1500UF 20% 400V SNAP	Manufacturers: Electro-Films (EFI) / Vishay	RFQ
	Part#: MAL209636182E3 Description: CAP ALUM 1800UF 20% 400V SNAP	Manufacturers: Electro-Films (EFI) / Vishay	RFQ
	Part#: MAL209629681E3 Description: CAP ALUM 680UF 20% 500V SNAP	Manufacturers: Electro-Films (EFI) / Vishay	RFQ
	Part#: MAL209629102E3 Description: CAP ALUM 1000UF 20% 500V SNAP	Manufacturers: Electro-Films (EFI) / Vishay	RFQ
	Part#: MAL209629821E3 Description: CAP ALUM 820UF 20% 500V SNAP	Manufacturers: Electro-Films (EFI) / Vishay	RFQ
	Part#: MAL209634222E3 Description: CAP ALUM 2200UF 20% 420V SNAP	Manufacturers: Electro-Films (EFI) / Vishay	RFQ
	Part#: MAL209636102E3 Description: CAP ALUM 1000UF 20% 400V SNAP	Manufacturers: Electro-Films (EFI) / Vishay	RFQ
	Part#: MAL209637122E3 Description: CAP ALUM 1200UF 20% 450V SNAP	Manufacturers: Electro-Films (EFI) / Vishay	RFQ
	Part#: MAL209635182E3 Description: CAP ALUM 1800UF 20% 350V SNAP	Manufacturers: Electro-Films (EFI) / Vishay	RFQ
	Part#: MAL209634182E3 Description: CAP ALUM 1800UF 20% 420V SNAP	Manufacturers: Electro-Films (EFI) / Vishay	RFQ
	Part#: MAL209636272E3 Description: CAP ALUM 2700UF 20% 400V SNAP	Manufacturers: Electro-Films (EFI) / Vishay	RFQ
	Part#: MAL209629561E3 Description: CAP ALUM 560UF 20% 500V SNAP	Manufacturers: Electro-Films (EFI) / Vishay	RFQ
	Part#: MAL209634152E3 Description: CAP ALUM 1500UF 20% 420V SNAP	Manufacturers: Electro-Films (EFI) / Vishay	RFQ
	Part#: MAL209636122E3 Description: CAP ALUM 1200UF 20% 400V SNAP	Manufacturers: Electro-Films (EFI) / Vishay	RFQ

Related keywords for MAL209635272E3

Electro-Films (EFI) / Vishay MAL209635272E3	MAL209635272E3 distributor	MAL209635272E3 supplier	MAL209635272E3 price
MAL209635272E3 download datasheet	MAL209635272E3 datasheet	MAL209635272E3 stock	buy MAL209635272E3
Electro-Films (EFI) / Vishay MAL209635272E3	Electro-Films (EFI) / Vishay MAL209635272E3	Vishay Electro-Films MAL209635272E3	Phoenix Passive Components / Vishay MAL209635272E3